

## PRO-52T | UNIVERSAL TAPPING AND DRILLING MACHINE



The PRO-52T drilling machine is suitable for hole cutting and tapping applications.

Powerful 1600 W variable speed motor enables milling capacity up to 50mm (2") and drilling capacity up to 23 mm (7/8").

Machine's forward & reverse work modes allow thread cutting up to M20 with Promotech's new tapping system.

Two speed gearbox with continuous speed adjustment allows to set the optimal speed depending on diameter, steel grade or tool quality.

Intelligent speed control system maintains constant motor speed regardless of changing loads.

Innovative 360-degree LED indicator facilitates proper machine operation and increases work safety.

### Features and benefits:

- 1600 W powerful motor with heavy duty 2-speed gearbox
- intelligent speed control system maintains stable speed regardless of load changes
- tapping of through and blind holes
- milling with TCT or HSS cutters or drilling
- electronic speed control
- electronic clutch
- both overload and overheat protection
- rigid design extends tool life
- tilt sensor stops the motor in cases of machines break away
- 360-degree visual monitoring system indicates current condition of the drill and gives safety and diagnostic information e.g. worn brushes
- innovative smart magnet with reduced weight
- intuitive control panel at top of the drill
- large coolant container



Core drill  
max 50 mm  
(2")



Twist drill  
max 23 mm  
(7/8")

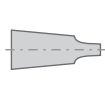

Spindle  
MT2



Depth of cut  
75 mm  
(3")



Stroke  
190 mm  
(7-1/2")



Speed  
160-250 rpm  
390-580 rpm



Motor Power  
1600 W



Weight  
17 kg  
37 (lbs)



Thread cutting  
M20  
(3/4")



Worn  
brushes  
indicator



Thermal  
/overheat  
protection



Overload  
protection



Tapping through holes up to M20



Tapping blind holes up to M20



Counterclockwise (CCW) rotation  
User-friendly control of tapping tool release

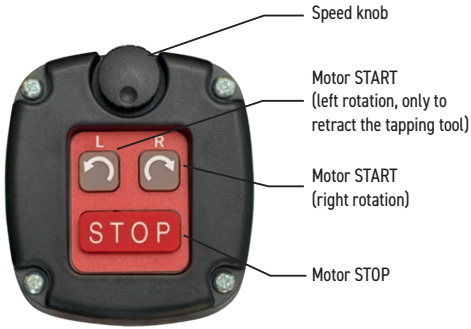

Intuitive control panel at top of the drill



Milling capacity up to 50 mm (2")  
• Max depth up to 75 mm (3")



Drilling capacity up to 23 mm (7/8")  
• Max stroke up to 190 mm (7-1/2")

### 360-degree Visual Monitoring System - VMS

	CONDITION OF THE DRILL		ready to work (green is on)
			normal work (white is on)
			overheat (red is on)
			emergency stop/overload (blue is on)
			emergency stop/tilting the machine due to vibrations or weak surface (violet is on)
	SAFETY INFORMATION		low adhesive force (green flashes)
			near overload (blue flashes)
	DIAGNOSTIC INFORMATION		emergency stop/ voltage drop (red changes to blue)
			emergency stop/ worn brushes (red changes to green)



### Promotech introduces quick change tapping system including:



- TC - Tapping chucks with securing nut
- TA - Tapping Adapters for through holes
- TASC - Tapping Adapters Safety Clutch for blind holes
- RA - Reduction Adapters

Tapping tool	Tapping chucks	
	MT2-19	MT2-31
M8	TA-1 or TASC-1	TA-1 or TASC-1 along with optional RA 2/1
M10		
M12		
M8	TA-2 or TASC-2	
M10		
M12		
M14		
M16		
M18		
M20		
Standard tapping configuration		Optional tapping configuration

**■** Promotech quick change tapping system accessories suitable for PRO-52T drilling machine:



Tapping chuck feat. securing nut

### TC – Tapping chucks with securing nuts

Product Code	Type	Description
OPR-0584-06-00-00-1	MT2-19	Tapping chuck MT2 x 19 mm
OPR-0584-10-00-00-1	MT2-31	Tapping chuck MT2 x 31 mm

### TA – Tapping Adapters

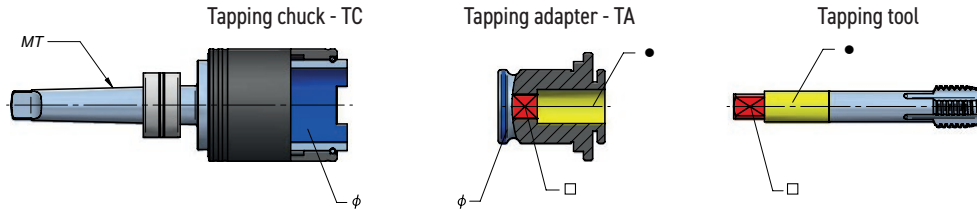

Product Code	Type	Description	∅ [mm]	Tap size	● [mm]	□ [mm]
WKL-000069	TA-1	Tapping Adapter 19 mm x M8	19	M8	8	6,2
WKL-000070	TA-1	Tapping Adapter 19 mm x M10	19	M10	10	8
WKL-000071	TA-1	Tapping Adapter 19 mm x M12	19	M12	9	7
WKL-000072	TA-2	Tapping Adapter 31 mm x M8	31	M8	8	6,2
WKL-000073	TA-2	Tapping Adapter 31 mm x M10	31	M10	10	8
WKL-000074	TA-2	Tapping Adapter 31 mm x M12	31	M12	9	7
WKL-000075	TA-2	Tapping Adapter 31 mm x M14	31	M14	11	9
WKL-000076	TA-2	Tapping Adapter 31 mm x M16	31	M16	12	9
WKL-000077	TA-2	Tapping Adapter 31 mm x M18	31	M18	14	11
WKL-000078	TA-2	Tapping Adapter 31 mm x M20	31	M20	16	12

### TASC – Tapping Adapters Safety Clutch

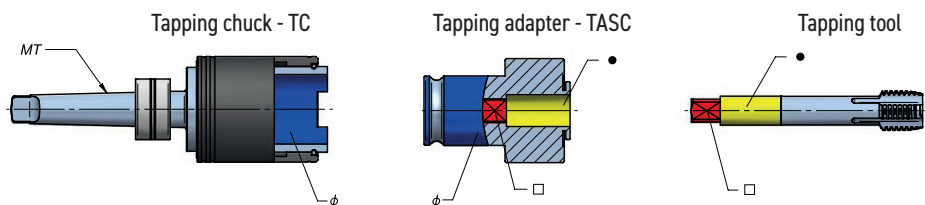

Product Code	Type	Description	∅ [mm]	Tap size	● [mm]	□ [mm]
WKL-000095	TASC-1	Tapping Adapter with Safety Clutch 19 mm x M8	19	M8	8	6,2
WKL-000098	TASC-1	Tapping Adapter with Safety Clutch 19 mm x M10	19	M10	10	8
WKL-000099	TASC-1	Tapping Adapter with Safety Clutch 19 mm x M12	19	M12	9	7
WKL-000100	TASC-2	Tapping Adapter with Safety Clutch 31 mm x M8	31	M8	8	6,2
WKL-000101	TASC-2	Tapping Adapter with Safety Clutch 31 mm x M10	31	M10	10	8
WKL-000102	TASC-2	Tapping Adapter with Safety Clutch 31 mm x M12	31	M12	9	7
WKL-000103	TASC-2	Tapping Adapter with Safety Clutch 31 mm x M14	31	M14	11	9
WKL-000104	TASC-2	Tapping Adapter with Safety Clutch 31 mm x M16	31	M16	12	9
WKL-000105	TASC-2	Tapping Adapter with Safety Clutch 31 mm x M18	31	M18	14	11
WKL-000106	TASC-2	Tapping Adapter with Safety Clutch 31 mm x M20	31	M20	16	12

### RA – Reduction Adapters

Product Code	Type	Description
RDC-000008	RA 2/1	Reduction Adapter 2/1 (31 mm / 19 mm)

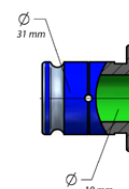

PRO-52T TECHNICAL SPECIFICATION	
Motor Speeds (under load)	160-250 rpm (gear I) 390-580 rpm (gear II)
Motor Power	1600 W
Weight	17 kg (37 lbs)
Max milling capacity	50 mm (2")
Max drilling capacity	23 mm (7/8")
Max Tap size	M20 (3/4")
Stroke	190 mm (7-1/2")
Max depth of cut	75 mm (3") *
Voltage	1- 220-240 V, 50-60 Hz 1- 110-120 V, 50-60 Hz
Magnetic clamping force (surface with the thickness of 25 mm and roughness Ra = 1.25)	1122 kG (11 000 N)
Magnet Base Dimensions	90 mm × 180 mm × 48 mm 3-9/16" × 7" × 1-7/8"
Min. Workpiece Thickness	8 mm (5/16)
Spindle	MT2
Tool holder	19 mm (3/4") Weldon
Product Code 220-240 V, 50-60 Hz	WRT-0600-10-20-00-0
Product Code 110-120 V, 50-60 Hz	WRT-0600-10-10-00-0

\* If more than 51 mm (2"), use AMT2-C19/2-3 Arbor (UCW-0220-00-00-00-4).

## Dimensions:

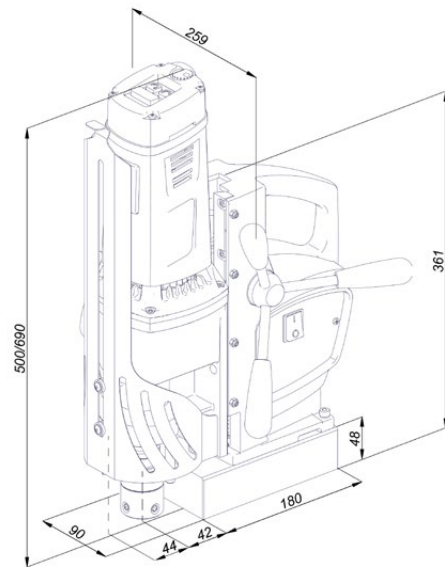

### Standard shipping set:

- Drilling machine
- Metal box
- Handle (3 pcs)
- MT2 arbor with 19 mm (3/4") Weldon tool holder
- Safety strap
- Cooling system
- Protective spring for cooling hose
- MT2 drift
- 6 mm hex wrench
- 5 mm hex wrench with a handle
- 2.5 mm hex wrench
- 8 mm combination wrench
- Tool can
- Locking connector (only in 115 V version)
- Operator's Manual

### More optional accessories:



Arbor AMT2-C19/2-3  
for 75 mm (3") depth cutting  
product code: UCW-0220-00-00-00-4



Pressure cooling system capacity of 2 liters  
product code: UKL-0440-16-00-00-0



Vacuum pad  
product code: PDS-0587-00-00-00-0



Compressed air ejector  
product code: ZSP-0587-11-00-00-0



Pipe attachment DMP 251  
for pipes with diameters of  
80-250 mm (3-10")  
product code: PDS-0110-03-00-01-0

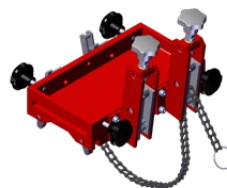

Pipe attachment DMP 501  
for pipes with diameters of  
150-500 mm (6-20")  
product code: PDS-0111-03-00-01-0



PROMOTECH Sp. z o.o.  
ul. Elewatorska 23/1, 15-620 BIAŁYSTOK, POLAND  
tel. (+48 85) 678 34 05, fax (+48 85) 662 78 77  
marketing@promotech.eu www.promotech.eu

Your local dealer:

